



TRANSFORMER-LIFE-MANAGEMENT  
CONFERENCE

## A general Overview of Analytical Measurement on Transformer Oil

**Gernoth Dobianer**  
Managing Director, Energy Support



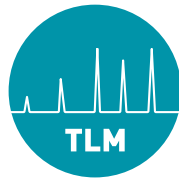

## A general Overview of Analytical Measurement on Transformer Oil

**ENERGY** SUPPORT

Experts in providing mobile Solutions

### A General Overview of Analytical Measurements on Transformer Oil

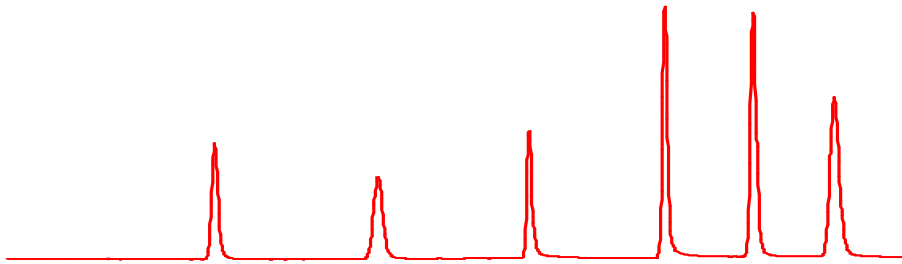

Transformer failures could be a disaster



- 520 MVA Transformer
- 6.0 million € replacement cost
- 0.5 million € environmental cleanup
- 1.5 million €/day spot market buy
- 18 million € loss in eight days!!
- 24/36 months replacement time



## TRANSFORMER-LIFE-MANAGEMENT CONFERENCE

# A general Overview of Analytical Measurement on Transformer Oil

Transformer failures on the increase...

The average age of US transformers ~ 42 Years

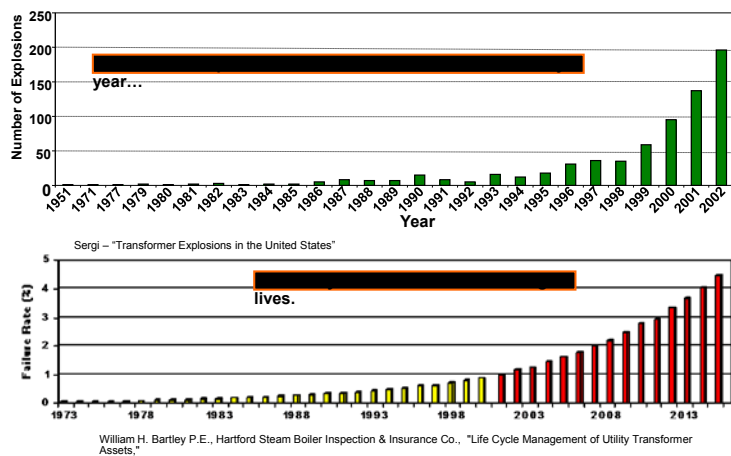

## Transformer Asset Management

- Transformers are a critical and costly element in the electrical grid
- Unplanned failures at any point in the transformer lifecycle have major consequences

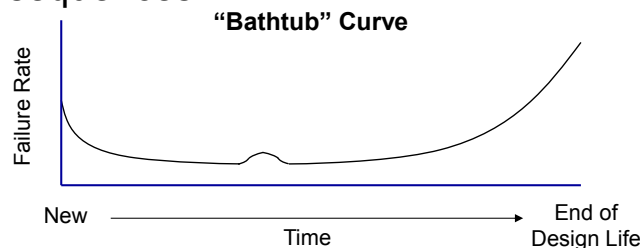

- DGA condition assessment has been recognized for over 30 years for improving reliability and lowering transformer asset maintenance costs

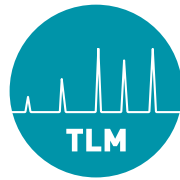

## TRANSFORMER-LIFE-MANAGEMENT CONFERENCE

# A general Overview of Analytical Measurement on Transformer Oil

**ENERGY** SUPPORT

Experts in providing mobile Solutions

### Which tests can you do on transformer oil on-site?

- Breakdown voltage tests
- Tan Delta and resistivity tests
- Water content measurement acc. to Karl-Fischer
- Interfacial Tension according ASTM 971
- Total gas content measurement
- Corrosive Copper Test
- Dissolved Gas Analysis

**The total of all parameters allows a diagnostic about the condition of the transformer**

Energy Support GmbH . Sperberweg 47 . D - 41468 Neuss T +49 2131 4039607 . F +49 2131 4039608 . info@energy-support.de

**ENERGY** SUPPORT

Experts in providing mobile Solutions

### Break Down Voltage Analyzer

- Fully automatic testing sequence
- up to 100 kV for mineral, ester and silicone oils
- According several standards VDE-IEC-ASTM
- BA Control Software, USB Connection and Bluetooth
- Internal rechargeable Battery



Energy Support GmbH . Sperberweg 47 . D - 41468 Neuss T +49 2131 4039607 . F +49 2131 4039608 . info@energy-support.de

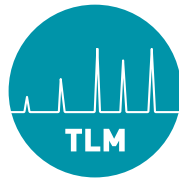

## TRANSFORMER-LIFE-MANAGEMENT CONFERENCE

# A general Overview of Analytical Measurement on Transformer Oil

**ENERGY** SUPPORT

Experts in providing mobile Solutions

### Tan Delta and Resistivity Measurement

- Fully automatic testing sequence
- Optional manual testing sequence
- Automatic calibration and resistance measurement
- Windows software
- Menu driven software operations

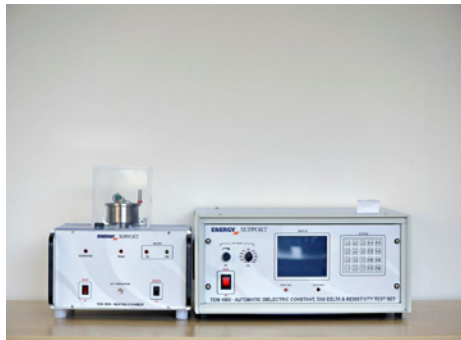

Energy Support GmbH . Sperberweg 47 . D - 41468 Neuss T +49 2131 4039607 . F +49 2131 4039608 . info@energy-support.de

**ENERGY** SUPPORT

Experts in providing mobile Solutions

### Pocket Titrator

- Low background drift measuring cell
- Preconfigured methods
- “One click” measurement
- AEC (automatically electrolysis controlled)
- High precision even in low concentrations
- Suitable for all commonly used Karl-Fischer-reagents



Energy Support GmbH . Sperberweg 47 . D - 41468 Neuss T +49 2131 4039607 . F +49 2131 4039608 . info@energy-support.de

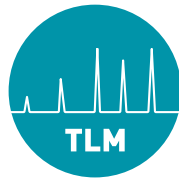

## TRANSFORMER-LIFE-MANAGEMENT CONFERENCE

# A general Overview of Analytical Measurement on Transformer Oil

**ENERGY** SUPPORT

Experts in providing mobile Solutions

### Interfacial Tensiometer

- Measurement in transformer oil made easy
- Accord. to ASTM-D971 and IEC60422
- Requires no knowledge of IT measurement
- Step by Step instructions
- Large LCD display
- Immediate display of data on screen



Energy Support GmbH . Sperberweg 47 . D - 41468 Neuss T +49 2131 4039607 . F +49 2131 4039608 . info@energy-support.de

**ENERGY** SUPPORT

Experts in providing mobile Solutions

### Total Gas Content Measurement

- Gas separation by means of fully vacuum degassing ( accord. to DIN EN 60567, DIN IEC 599 and IEEE C57.104-1991) and display of results
- Subsequently to the determination of the total gas content a gas chromatographic analysis can be made.



Energy Support GmbH . Sperberweg 47 . D - 41468 Neuss T +49 2131 4039607 . F +49 2131 4039608 . info@energy-support.de

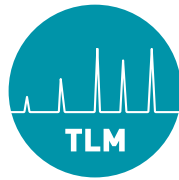

## TRANSFORMER-LIFE-MANAGEMENT CONFERENCE

# A general Overview of Analytical Measurement on Transformer Oil

**ENERGY** SUPPORT

Experts in providing mobile Solutions

### Corrosive Copper Test Kit

Portable Test Kit  
according IEC 62535 and  
ASTM D 1275/B  
Easy to use  
with prepared samples  
individually cleaned,  
packed with or without paper



Energy Support GmbH . Sperberweg 47 . D - 41468 Neuss T +49 2131 4039607 . F +49 2131 4039608 . info@energy-support.de

**ENERGY** SUPPORT

Experts in providing mobile Solutions

### Dissolved Gas Analyse with TOP-TOGA- GC

Features and Benefits:

- Fully automatic procedure
- One touch operation
- Multi-periodic vacuum degassing
- Fast and reliable
- Full TOGA analysis ( 11 gases )
- Automatic transfer of gas sample
- Compl. to ASTM3612 / IEC 567



Energy Support GmbH . Sperberweg 47 . D - 41468 Neuss T +49 2131 4039607 . F +49 2131 4039608 . info@energy-support.de

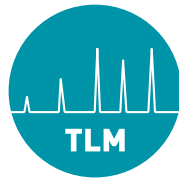

## TRANSFORMER-LIFE-MANAGEMENT CONFERENCE

# A general Overview of Analytical Measurement on Transformer Oil

**ENERGY** SUPPORT

Experts in providing mobile Solutions

## TOP-TOGA- GC with Autosampler

### Features and Benefits:

- Fully automatic procedure for dosing the oil with 16 Syringes
- One touch operation
- Multi-periodic vacuum degassing
- Fast and reliable
- Full TOGA analysis ( 11 gases )
- Automatic transfer of gas sample
- Compl. to ASTM3612 / IEC 567



Energy Support GmbH . Sperberweg 47 . D - 41468 Neuss T +49 2131 4039607 . F +49 2131 4039608 . [info@energy-support.de](mailto:info@energy-support.de)

**ENERGY** SUPPORT

Experts in providing mobile Solutions

## TOP-TOGA- GC for Heat Run Test according IEC 61181

### Features and Benefits:

Same as the TOP TOGA  
Fully automatic procedure  
for dosing the oil out of  
the Transformer  
High sensitivity according  
ASTM / IEC Standards



Energy Support GmbH . Sperberweg 47 . D - 41468 Neuss T +49 2131 4039607 . F +49 2131 4039608 . [info@energy-support.de](mailto:info@energy-support.de)





## TRANSFORMER-LIFE-MANAGEMENT CONFERENCE

# A general Overview of Analytical Measurement on Transformer Oil

**ENERGY** SUPPORT

Experts in providing mobile Solutions

### What is Dissolved Gas Analysis?

**A quantitative analysis of all dissolved gases in the transformer oil. The analysis is done after the extraction of the gases and a gas chromatography thereafter.**

**The aim of the analysis is an early determination of aging and functional problems of the transformer.**

**Availability is more important than reliability**

**PREDICTIVE MAINTENANCE !**

Energy Support GmbH . Sperberweg 47 . D - 41468 Neuss T +49 2131 4039807 . F +49 2131 4039808 . info@energy-support.de

## Monitoring of Gases in Transformers

- **Gas originates from many places:**
  - ✓ Mineral insulating oil
  - ✓ Conductor paper insulation
  - ✓ Pressboard barriers
  - ✓ Other materials
- **Gas generation is related to high material temperatures (150°C to 1,000°C)**
- **Gases are symptoms of:**
  - ✓ Poor design or construction
  - ✓ Too much electrical stress
  - ✓ Too much thermal stress
  - ✓ Too many short circuits
  - ✓ Overall poor condition





## A general Overview of Analytical Measurement on Transformer Oil

# DGA Process

## Gassing in Transformers

- DGA detects the level of gases indicative of incipient faults which could lead to transformer failure.
- There are 11 incipient fault gases recognized by the ASTM and IEC

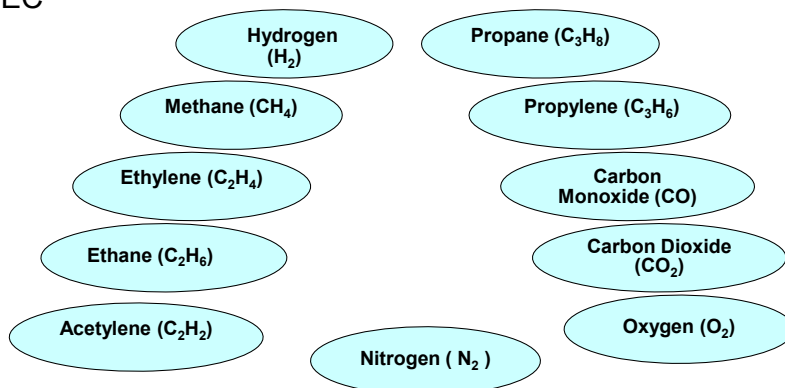

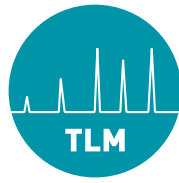

**TRANSFORMER-LIFE-MANAGEMENT  
CONFERENCE**

## A general Overview of Analytical Measurement on Transformer Oil

### Fault Gas Indications with ON-LINE SYSTEM

	H <sub>2</sub>	CO	CO <sub>2</sub>	CH <sub>4</sub>	C <sub>2</sub> H <sub>2</sub>	C <sub>2</sub> H <sub>4</sub>	C <sub>2</sub> H <sub>6</sub>	C <sub>3</sub> H <sub>8</sub>	C <sub>3</sub> H <sub>6</sub>	O <sub>2</sub>	H <sub>2</sub> O
Cellulose decomposition		✓	✓								✓
Mineral oil decomposition	✓			✓	✓	✓	✓				
Leaks in oil expansion systems, gaskets, welds ...			✓							✓	✓
Thermal faults – Cellulose	✓	✓	✓	✓						✓	
Thermal faults in Oil @ 150°C-300°C	✓			✓		trace	✓	✓			
Thermal faults in Oil @ 300°C-700°C	✓			✓	trace	✓	✓		✓		
Thermal faults in Oil @ over 700°C	✓			✓	✓	✓			trace		
Partial Discharge	✓			✓	trace						
Arcing	✓			✓	✓	✓					

**ENERGY** SUPPORT

Experts in providing mobile Solutions

### Which gases need to be detected ?

accord. to ASTM 3612 / IEC 567

#### ASTM 3612

- Oxygen O<sub>2</sub>, Nitrogen N<sub>2</sub>
- Hydrogen H<sub>2</sub>
- Carbon Monoxid CO, Carbon Dioxid CO<sub>2</sub>
- Methan CH<sub>4</sub>
- Ethan C<sub>2</sub>H<sub>6</sub>
- Ethylen C<sub>2</sub>H<sub>4</sub>
- Acetylen C<sub>2</sub>H<sub>2</sub>
- Propan C<sub>3</sub>H<sub>8</sub>
- Propylen C<sub>3</sub>H<sub>6</sub>

#### IEC 567

- Oxygen O<sub>2</sub>, Nitrogen N<sub>2</sub>
- Hydrogen H<sub>2</sub>
- Carbon Monoxid CO, Carbon Dioxid CO<sub>2</sub>
- Methan CH<sub>4</sub>
- Ethan C<sub>2</sub>H<sub>6</sub>
- Ethylen C<sub>2</sub>H<sub>4</sub>
- Acetylen C<sub>2</sub>H<sub>2</sub>
- (Propan C<sub>3</sub>H<sub>8</sub>, Propylen C<sub>3</sub>H<sub>6</sub>)

Energy Support GmbH · Sperberweg 47 · D - 41468 Neuss T +49 2131 4039607 · F +49 2131 4039608 · info@energy-support.de



## TRANSFORMER-LIFE-MANAGEMENT CONFERENCE

# A general Overview of Analytical Measurement on Transformer Oil

**ENERGY** SUPPORT

Experts in providing mobile Solutions

### The Use of Atmospheric Gases

**N2 and O2 are indispensable for the evaluation of  
the transformer condition**

**N2: Referenzvalue for the gas saturation.**

**O2: Very important indicator for the ageing process**

Energy Support GmbH . Sperberweg 47 . D - 41468 Neuss T +49 2131 4039607 . F +49 2131 4039608 . info@energy-support.de

**ENERGY** SUPPORT

Experts in providing mobile Solutions

### Steps of the Dissolved Gas Analysis

- Sampling of Oil
- Degassing
- Gas chromatography
- Interpretation of the values with integrated expert - system

Energy Support GmbH . Sperberweg 47 . D - 41468 Neuss T +49 2131 4039607 . F +49 2131 4039608 . info@energy-support.de

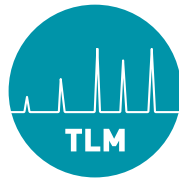

## TRANSFORMER-LIFE-MANAGEMENT CONFERENCE

# A general Overview of Analytical Measurement on Transformer Oil

**ENERGY** SUPPORT

Experts in providing mobile Solutions

### Margin of Error in DGA

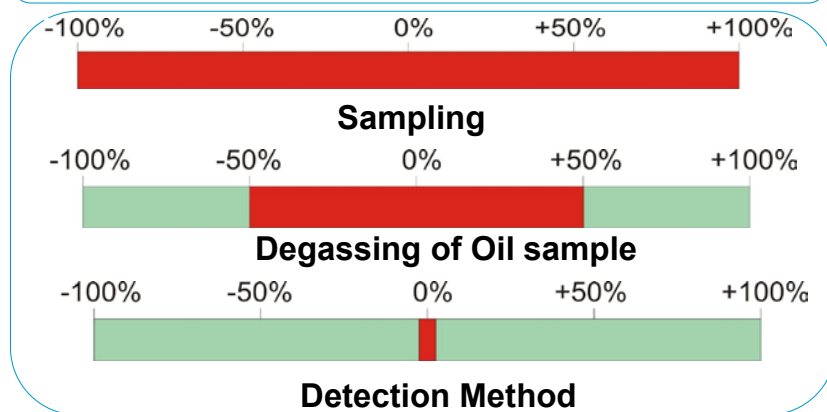

Energy Support GmbH · Sperberweg 47 · D - 41468 Neuss · T +49 2131 4039807 · F +49 2131 4039808 · info@energy-support.de

## Oil Sampling

- **Manual Sampling**
  - A small volume of oil (50 or 100 mL) is collected in a gas-tight syringe, using a contamination free oil sampling set with 2-way valve and temperature controlled sampler, then transported to the laboratory
  - ASTM method D3613 details procedures for oil sample handling
- **On-Line Sampling**
  - The automatic degassing system is coupled with the quantitative gas analysis of the separated gases inside a weather-resistant cabinet. The transformer oil is withdrawing at the lower sample valve of the transformer. For rinsing all tubes inside the Online-DGA with the actual sample the oil circulates in a return flow to the expansion vessel on top of the transformer. The actual oil sample is cooling down inside the air-conditioned cabinet to reach a constant temperature for the gas analysis.
  - On-Line monitors offer a closed-loop repeatable oil sampling process, with no possibility for contamination



## TRANSFORMER-LIFE-MANAGEMENT CONFERENCE

# A general Overview of Analytical Measurement on Transformer Oil

**ENERGY** SUPPORT

Experts in providing mobile Solutions

### Avoid Missinterpretation of your Oilsamples

Results are strongly dependent on Temperature and Oil Ageing Conditions

Temperature in C	80	15	46
Dielectric Strength	13	70	45
Water in Oil(mg/kg)	48	10	20

So don't miss the information about Oil temperature  
when you take your Oilsample

Energy Support GmbH . Sperberweg 47 . D - 41468 Neuss T +49 2131 4039607 . F +49 2131 4039608 . info@energy-support.de

**ENERGY** SUPPORT

Experts in providing mobile Solutions

### Where does the water come from?

Moisture can be in the insulation when it is delivered from factory.

If the transformer is opened for inspection or has a leak,

the insulation can absorb moisture from the atmosphere.

Moisture is also formed by the degradation of insulation as the transformer ages.

Energy Support GmbH . Sperberweg 47 . D - 41468 Neuss T +49 2131 4039607 . F +49 2131 4039608 . info@energy-support.de

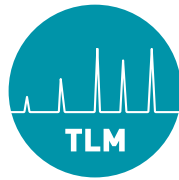

**TRANSFORMER-LIFE-MANAGEMENT  
CONFERENCE**

# A general Overview of Analytical Measurement on Transformer Oil

**ENERGY** SUPPORT

Experts in providing mobile Solutions

## Contamination Free Oilsampling

- Contamination free
- without ambient air
- without humidity
- automatic measurement of the oil temperature

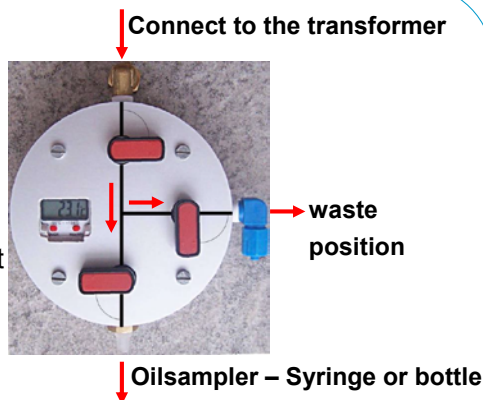

Energy Support GmbH . Sperberweg 47 . D - 41468 Neuss T +49 2131 4039807 . F +49 2131 4039808 . info@energy-support.de

**ENERGY** SUPPORT

Experts in providing mobile Solutions

## Contamination Free Oilsampling

- Delivered with:
- 2 Syringes
  - Sampling Modul
  - 2 Aluminium Bottles
  - Plastic Case



Energy Support GmbH . Sperberweg 47 . D - 41468 Neuss T +49 2131 4039807 . F +49 2131 4039808 . info@energy-support.de



## TRANSFORMER-LIFE-MANAGEMENT CONFERENCE

# A general Overview of Analytical Measurement on Transformer Oil

**ENERGY** SUPPORT

Experts in providing mobile Solutions

### Film about correct Contamination Free Oilsampling



Energy Support GmbH . Sperberweg 47 . D - 41468 Neuss T +49 2131 4039607 . F +49 2131 4039608 . info@energy-support.de

**ENERGY** SUPPORT

Experts in providing mobile Solutions

### Degassing Methods accord. to ASTM 3612 / IEC 60567

- Multi periodic vacuum degassing
- Headspace method – not suitable for factory test
- Partial vacuum degassing / Stripping method

Energy Support GmbH . Sperberweg 47 . D - 41468 Neuss T +49 2131 4039607 . F +49 2131 4039608 . info@energy-support.de



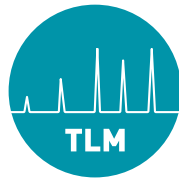

## TRANSFORMER-LIFE-MANAGEMENT CONFERENCE

# A general Overview of Analytical Measurement on Transformer Oil

**ENERGY** SUPPORT

Experts in providing mobile Solutions

### Gas - Analysis accord. to ASTM 3612 / IEC 60567

- Gas Chromatography using 2 columns
- TCD / FID Detector
- Methanizer

Energy Support GmbH . Sperberweg 47 . D - 41468 Neuss T +49 2131 4039607 . F +49 2131 4039608 . info@energy-support.de

**ENERGY** SUPPORT

Experts in providing mobile Solutions

### TOP-TOGA- GC with Autosampler

#### Features and Benefits:

- Fully automatic procedure for dosing the oil with 16 Syringes
- One touch operation
- Multi-periodic vacuum degassing
- Fast and reliable
- Full TOGA analysis ( 11 gases )
- Automatic transfer of gas sample
- Compl. to ASTM3612 / IEC 567



Energy Support GmbH . Sperberweg 47 . D - 41468 Neuss T +49 2131 4039607 . F +49 2131 4039608 . info@energy-support.de

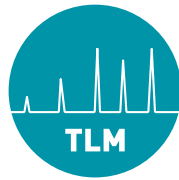

## TRANSFORMER-LIFE-MANAGEMENT CONFERENCE

# A general Overview of Analytical Measurement on Transformer Oil

**ENERGY** SUPPORT

Experts in providing mobile Solutions

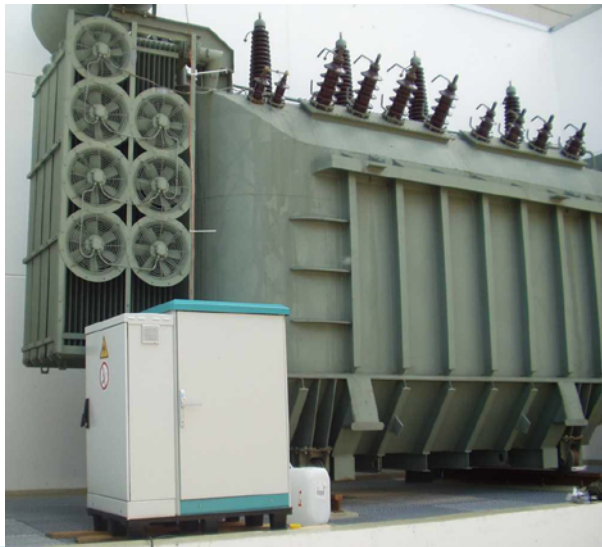

Energy Support GmbH . Sperberweg 47 . D - 41468 Neuss T +49 2131 4039607 . F +49 2131 4039608 . info@energy-support.de

**ENERGY** SUPPORT

Experts in providing mobile Solutions

### Merkmale:

- Contamination Free Oilsampling
- Monitoring of 11 Gases
- High Sensitivity
- Automatic Calibration
- Measuring the Total Gas Content
- Useful to do Factory Heat Run Test
- Detecting of Failures on an very early stage
- Forwarding the results via Internet or GSM
- Direct evaluation of results with internal Expertsystem
- Servicemodul for remote maintenance



Energy Support GmbH . Sperberweg 47 . D - 41468 Neuss T +49 2131 4039607 . F +49 2131 4039608 . info@energy-support.de

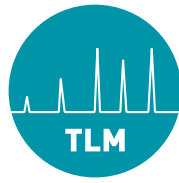

## TRANSFORMER-LIFE-MANAGEMENT CONFERENCE

# A general Overview of Analytical Measurement on Transformer Oil

**ENERGY** SUPPORT  
Experts in providing mobile Solutions

### Energy Support On-line DGA

- Multi periodic vacuum degassing
- 100 % de-gassing efficiency
- Measurement of Total Gas Content (TDGC)
- Reliable gas sample for reproducible DGA values

Energy Support GmbH . Sperberweg 47 . D - 41468 Neuss T +49 2131 4039607 . F +49 2131 4039608 . info@energy-support.de

### Automatic Online-Monitoring System according IEC and ASTM Standard in Detail

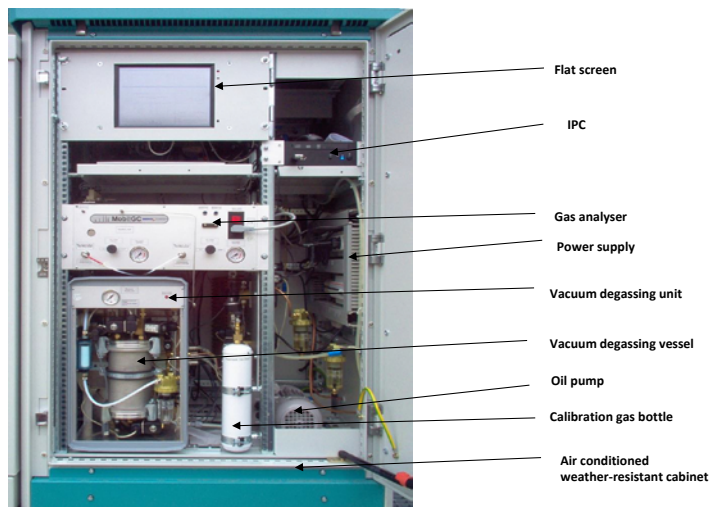

Energy Support GmbH . Sperberweg 47 . D - 41468 Neuss T +49 2131 4039607 . F +49 2131 4039608 . info@energy-support.de

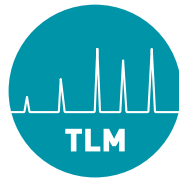

**TRANSFORMER-LIFE-MANAGEMENT  
CONFERENCE**

## A general Overview of Analytical Measurement on Transformer Oil

**ENERGY** SUPPORT

Experts in providing mobile Solutions

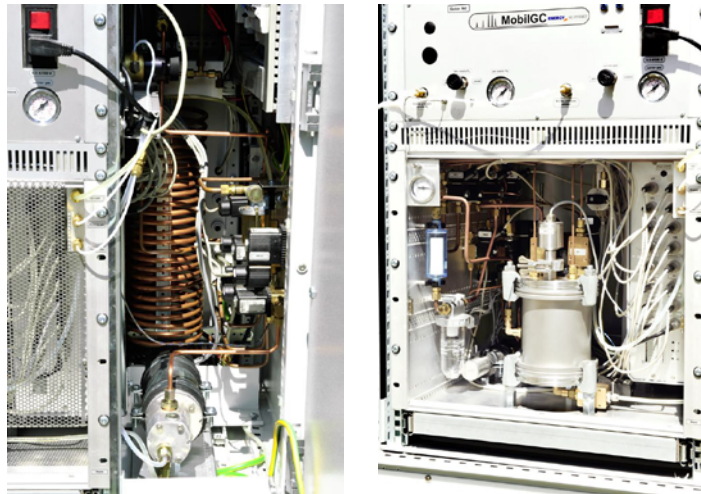

Energy Support GmbH . Sperberweg 47 . D - 41468 Neuss T +49 2131 4039607 . F +49 2131 4039608 . info@energy-support.de

**Example of Automatic Online-Monitoring  
System at Site**

**ENERGY** SUPPORT

Experts in providing mobile Solutions



Energy Support GmbH . Sperberweg 47 . D - 41468 Neuss T +49 2131 4039607 . F +49 2131 4039608 . info@energy-support.de



## TRANSFORMER-LIFE-MANAGEMENT CONFERENCE

# A general Overview of Analytical Measurement on Transformer Oil

### Example of Automatic Online-Monitoring System at Site

**ENERGY** SUPPORT

Experts in providing mobile Solutions



Energy Support GmbH . Sperberweg 47 . D - 41468 Neuss T +49 2131 4039607 . F +49 2131 4039608 . info@energy-support.de

**ENERGY** SUPPORT

Experts in providing mobile Solutions

## On – Line DGA for 2 Transformers



Energy Support GmbH . Sperberweg 47 . D - 41468 Neuss T +49 2131 4039607 . F +49 2131 4039608 . info@energy-support.de

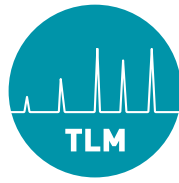

## TRANSFORMER-LIFE-MANAGEMENT CONFERENCE

# A general Overview of Analytical Measurement on Transformer Oil

**ENERGY** SUPPORT

Experts in providing mobile Solutions

### OnlineDGA T3 to analyse 3 Transformers

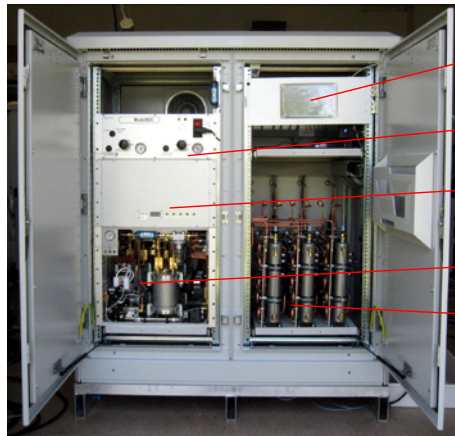

Display

Gaschromatograph

Steuereinheit

Vakuumentgasung

Ölzirkulation mit Ölrückführung  
(dreifach)

Energy Support GmbH . Sperberweg 47 . D - 41468 Neuss T +49 2131 4039607 . F +49 2131 4039608 . info@energy-support.de

**ENERGY** SUPPORT

Experts in providing mobile Solutions

### Connection on an Transformer



Connection to collect the Oil

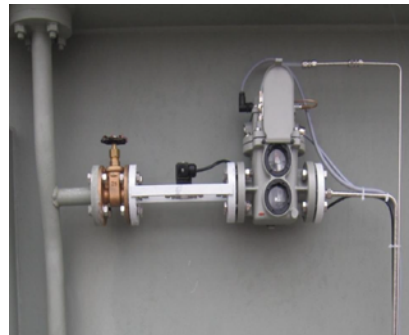

Connection to bring back the Oil

Energy Support GmbH . Sperberweg 47 . D - 41468 Neuss T +49 2131 4039607 . F +49 2131 4039608 . info@energy-support.de

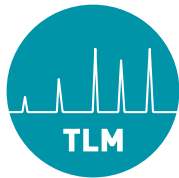

**TRANSFORMER-LIFE-MANAGEMENT  
CONFERENCE**

**A general Overview of Analytical Measurement  
on Transformer Oil**

Example to control 3 Transformers

**ENERGY SUPPORT**

Experts in providing mobile Solutions

Examples of Installation



OnlineDGA for 3 Transformers

Energy Support GmbH . Sperberweg 47 . D - 41468 Neuss T +49 2131 4039607 . F +49 2131 4039608 . info@energy-support.de

Schematic Diagram of Automatic Online-Monitoring System for 3 Transformers at a time

**ENERGY SUPPORT**

Experts in providing mobile Solutions

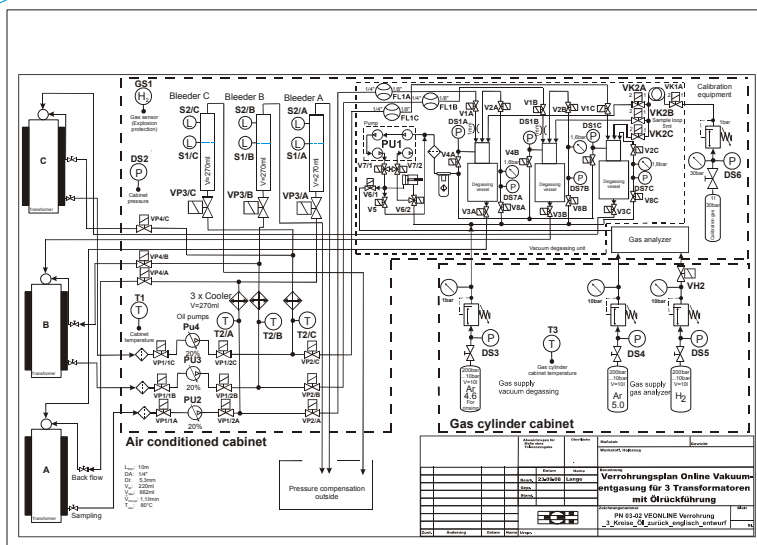

Energy Support GmbH . Sperberweg 47 . D - 41468 Neuss T +49 2131 4039607 . F +49 2131 4039608 . info@energy-support.de

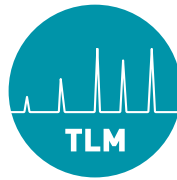

## TRANSFORMER-LIFE-MANAGEMENT CONFERENCE

# A general Overview of Analytical Measurement on Transformer Oil

Example of Remote monitoring of Online System

**ENERGY SUPPORT**

Experts in providing mobile Solutions

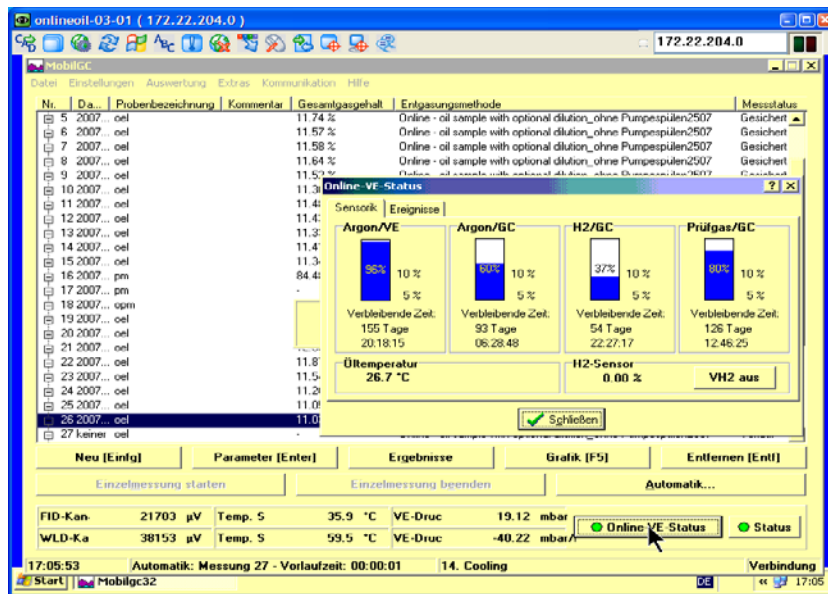

Energy Support GmbH · Sperberweg 47 · D - 41468 Neuss T +49 2131 4039607 · F +49 2131 4039608 · info@energy-support.de

Sample of Software view for Gas Analysis

**ENERGY SUPPORT**

Experts in providing mobile Solutions

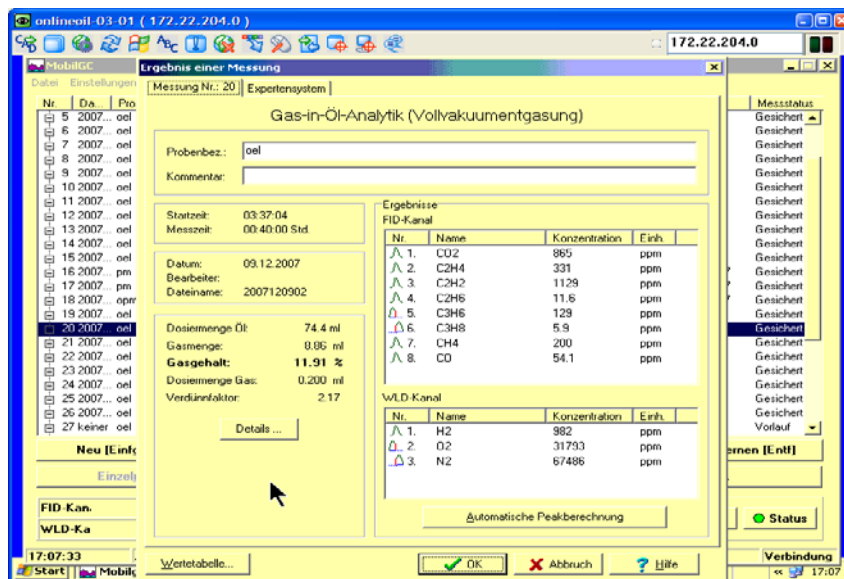

Energy Support GmbH · Sperberweg 47 · D - 41468 Neuss T +49 2131 4039607 · F +49 2131 4039608 · info@energy-support.de





**TRANSFORMER-LIFE-MANAGEMENT  
CONFERENCE**

**A general Overview of Analytical Measurement  
on Transformer Oil**

Example of Diagnostic Tool used in Online System

**ENERGY SUPPORT**

Experts in providing mobile Solutions

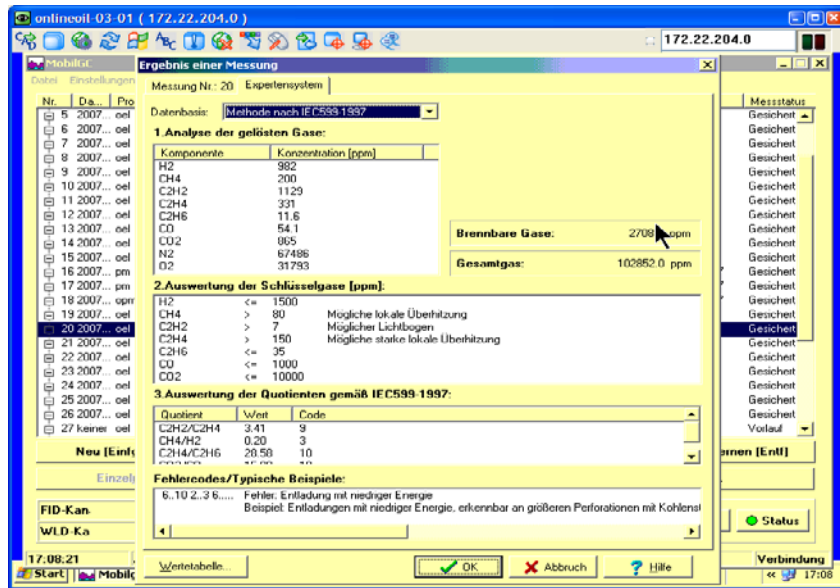

Energy Support GmbH · Sperberweg 47 · D - 41468 Neuss T +49 2131 4039607 · F +49 2131 4039608 · info@energy-support.de

**ENERGY SUPPORT**

Experts in providing mobile Solutions

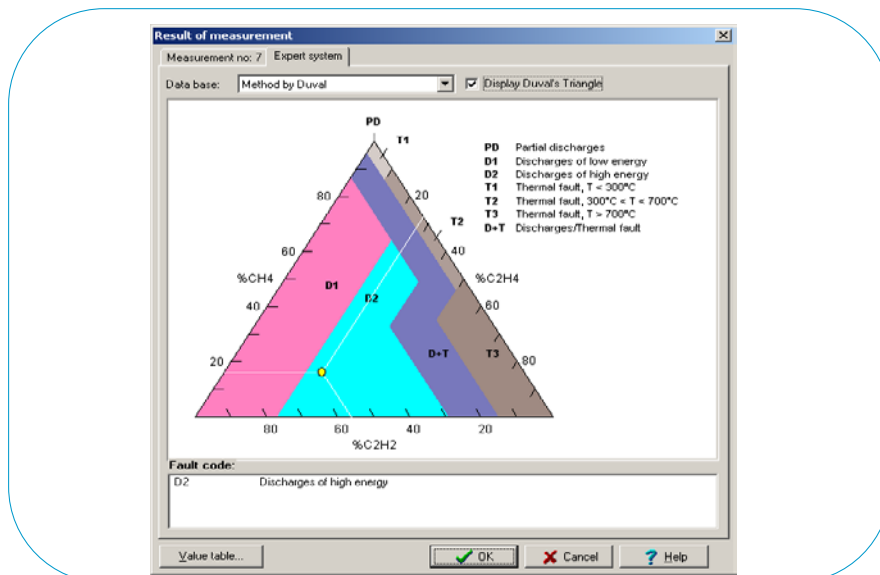

Energy Support GmbH · Sperberweg 47 · D - 41468 Neuss T +49 2131 4039607 · F +49 2131 4039608 · info@energy-support.de

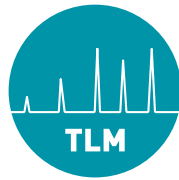

**TRANSFORMER-LIFE-MANAGEMENT  
CONFERENCE**

# A general Overview of Analytical Measurement on Transformer Oil

**ENERGY** SUPPORT

Experts in providing mobile Solutions

## Reasons for high gas content and interpretation of the values with ratios

<b>Electrical Discharge</b>		<u>Acetylene C2H2</u> > 3
		Ethan C2H6
<b>Partial Discharge</b>		<u>Hydrogen H2</u> > 10
		Methan CH4
<b>Overheating of Oil</b>	Ethylene C2H4	< 1 for temperatures below 300 °C
	Propylene C3H6	> 1 for temperatures over 300 °C
<b>Overheating of cellulosis</b>		<u>Carbon dioxide CO2</u> >10
		Carbon monoxide CO
<b>Degradation of cellulosis caused by elec. Faults</b>		<u>Carbon dioxide CO2</u> < 3
		Carbon monoxide CO
<b>Leakage, contamination of the oil with ambient air</b>		Oxygen O2
		Nitrogen N2
<b>Leaking tap changer vessel</b>		<u>Acetylen C2H2</u> >2
		Hydrogen H2

Energy Support GmbH · Sperberweg 47 · D - 41468 Neuss T +49 2131 4039807 · F +49 2131 4039808 · info@energy-support.de

## Different Diagnostic Tools Available In The System

Tool
Dornenburg Ratios
<b>TGC Procedure</b>
<b>TDCG Procedure</b>
<b>Key Gas Procedure</b>
<b>TCG Procedure</b>
Rogers Ratios
IEC Gas Ratios
IEC 599-1997 Ratio
Duval Triangle
CO <sub>2</sub> /CO Ratio
O <sub>2</sub> /N <sub>2</sub> Ratio
C <sub>2</sub> H <sub>2</sub> /H <sub>2</sub> Ratio



## TRANSFORMER-LIFE-MANAGEMENT CONFERENCE

# A general Overview of Analytical Measurement on Transformer Oil

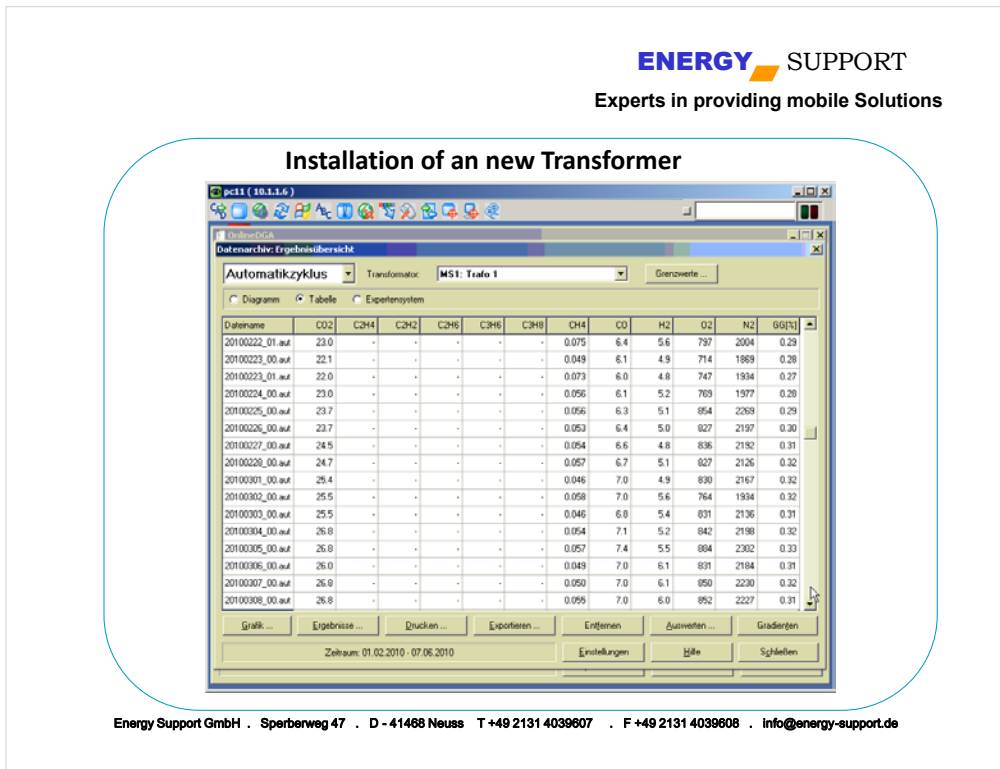
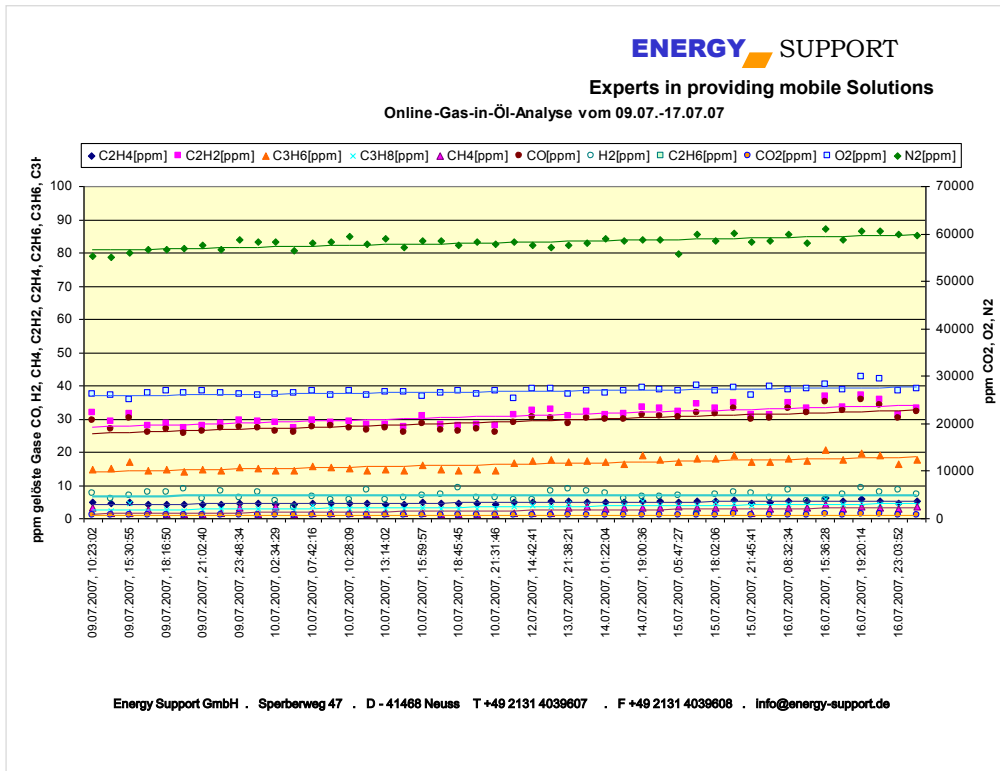



**TRANSFORMER-LIFE-MANAGEMENT  
CONFERENCE**

# A general Overview of Analytical Measurement on Transformer Oil

**ENERGY SUPPORT**

Experts in providing mobile Solutions

## Comissioning of new Transformer

Datensatz	CO2	C2H4	C2H2	C2H6	C2H8	C4H	CO	H2	O2	N2	g/g
20100306_00.auf	26.0	-	-	-	-	0.049	7.0	6.1	931	2104	0.31
20100307_00.auf	26.8	-	-	-	-	0.050	7.0	6.1	950	2230	0.32
20100308_00.auf	26.8	-	-	-	-	0.055	7.0	6.0	952	2227	0.31
20100511_00.auf	26.6	0.007	-	-	-	0.15	12.4	10.3	953	3005	0.44
20100512_00.auf	23.6	0.096	-	-	-	0.16	14.4	10.7	1047	3100	0.46
20100512_01.auf	23.4	0.11	-	-	-	0.19	14.2	10.6	990	2834	0.40
20100512_02.auf	28.6	0.12	-	-	-	0.17	14.7	10.7	1004	3291	0.49
20100513_00.auf	28.0	0.12	-	-	-	0.17	14.0	11.0	949	3005	0.39
20100513_01.auf	28.8	0.12	-	-	-	0.17	14.1	10.5	865	2809	0.37
20100513_02.auf	23.4	0.13	-	-	-	0.17	14.6	10.3	921	2933	0.40
20100514_00.auf	23.1	0.12	-	-	-	0.16	14.3	10.5	951	3045	0.39
20100515_00.auf	23.7	0.12	-	-	-	0.17	13.3	10.0	907	2966	0.34
20100519_00.auf	23.5	0.12	-	-	-	0.16	13.0	9.9	896	2764	0.33
20100520_00.auf	23.9	0.13	-	-	-	0.16	14.7	10.9	993	3203	0.40
20100521_00.auf	23.6	0.13	-	-	-	0.17	14.7	10.5	991	3211	0.40
20100522_00.auf	31.6	0.14	-	-	-	0.20	15.2	10.8	1018	3277	0.42

Energy Support GmbH . Sperberweg 47 . D - 41468 Neuss T +49 2131 4039607 . F +49 2131 4039608 . info@energy-support.de

**ENERGY SUPPORT**

Experts in providing mobile Solutions

## Monitoring of Transformer with Trendanalyse

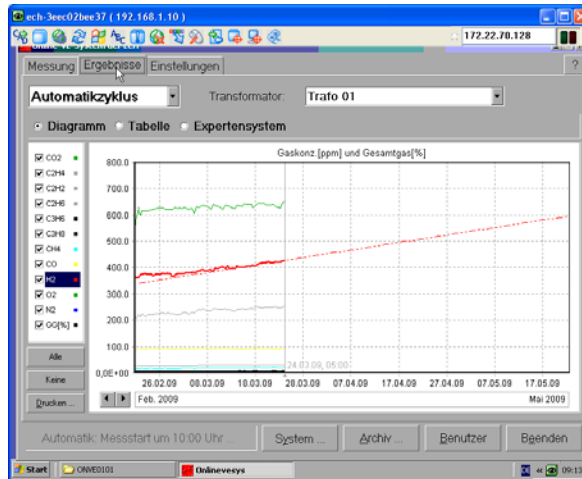

Energy Support GmbH . Sperberweg 47 . D - 41468 Neuss T +49 2131 4039607 . F +49 2131 4039608 . info@energy-support.de



## TRANSFORMER-LIFE-MANAGEMENT CONFERENCE

# A general Overview of Analytical Measurement on Transformer Oil

**ENERGY** SUPPORT

Experts in providing mobile Solutions

### Monitoring of DGA Analyse on Transformer

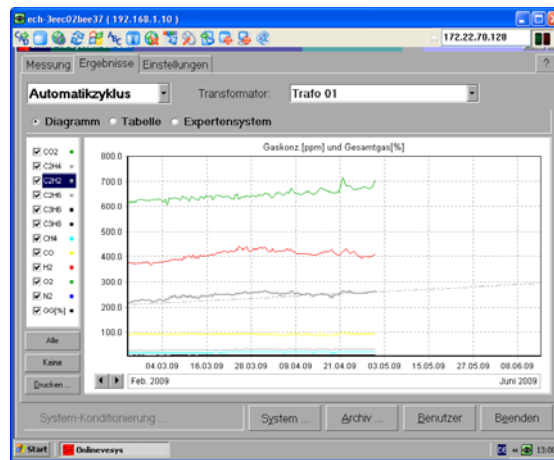

Energy Support GmbH . Sperberweg 47 . D - 41468 Neuss T +49 2131 4039607 . F +49 2131 4039608 . info@energy-support.de

**ENERGY** SUPPORT

Experts in providing mobile Solutions

### Problem with Isolatingmaterials in Transformer



Increasing CO und CO2 Konzentrationen

Energy Support GmbH . Sperberweg 47 . D - 41468 Neuss T +49 2131 4039607 . F +49 2131 4039608 . info@energy-support.de

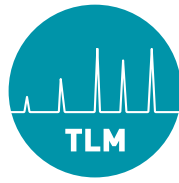

## TRANSFORMER-LIFE-MANAGEMENT CONFERENCE

# A general Overview of Analytical Measurement on Transformer Oil

**ENERGY** SUPPORT

Experts in providing mobile Solutions

### Oxidationsprozess in Transformer

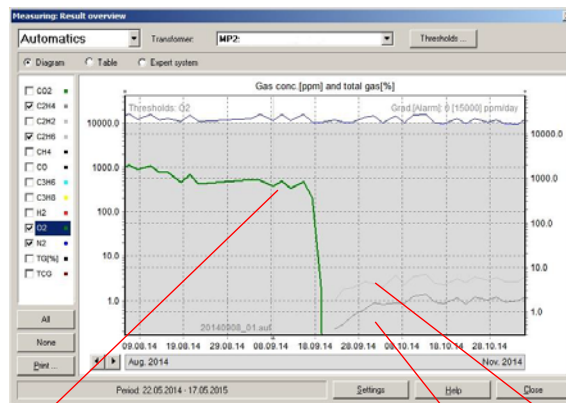

Massive Oxygen reducing  
Oxidationprocesses with rising of C2H4 and C2H6

Energy Support GmbH . Sperberweg 47 . D - 41468 Neuss T +49 2131 4039607 . F +49 2131 4039608 . info@energy-support.de

**ENERGY** SUPPORT

Experts in providing mobile Solutions

### Oxidationsprozess with H2 increasing



Oxidationprocesses with consume of  
O2 and rise up of H2

Energy Support GmbH . Sperberweg 47 . D - 41468 Neuss T +49 2131 4039607 . F +49 2131 4039608 . info@energy-support.de

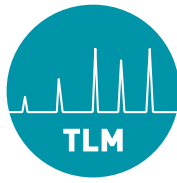

## TRANSFORMER-LIFE-MANAGEMENT CONFERENCE

# A general Overview of Analytical Measurement on Transformer Oil

**ENERGY** SUPPORT

Experts in providing mobile Solutions

### Increase of Total Gas Content

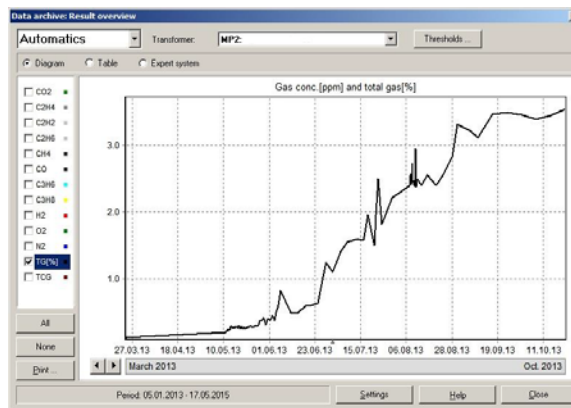

Increase of Total Gas Content, maybe there is a Leakage in Cooling System

Energy Support GmbH · Sperberweg 47 · D - 41468 Neuss T +49 2131 4039607 · F +49 2131 4039608 · info@energy-support.de

**ENERGY** SUPPORT

Experts in providing mobile Solutions

### Factory Test (Heat Run)

**Merkmale:**

- Direkt connection Online with your Transformer
- Oilcirculation
- Contaminationfree Oilsampling
- DGA with 11 Gases and Total Gascontent
- High Sensitivity, find Failures on a very early Stage

TABELLARSICHERE MESSÜBERSICHT Online DGA Seite 1/1  
Gerät: 5013004

Messstelle:	MS1: Trubo ABB	CO2	C2H4	C2H2	C2H6	C3H6	C3H8	CH4	CO	H2	O2	N2	GG[%]
21.09.09, 16:00	16.9	-	-	-	-	-	-	0.051	1.5	0.74	1079	1300	0.59
21.09.09, 17:00	16.4	-	-	-	-	-	-	0.050	1.7	0.82	1724	2983	0.79
21.09.09, 18:00	15.7	-	-	-	-	-	-	0.057	1.9	0.92	1837	4264	0.82
21.09.09, 19:00	15.4	-	-	-	-	-	-	0.072	1.5	0.83	1639	4105	0.69
21.09.09, 20:00	14.3	-	-	-	-	-	-	0.052	1.8	0.53	1730	4288	0.74
21.09.09, 21:00	14.7	-	-	-	-	-	-	0.035	1.7	0.76	1766	4206	0.72
21.09.09, 22:00	14.4	-	-	-	-	-	-	0.077	1.7	0.70	1687	4237	0.69
21.09.09, 22:00	14.1	-	-	-	-	-	-	0.051	1.6	0.51	1677	4321	0.68
22.09.09, 06:00	14.0	-	-	-	-	-	-	0.038	1.8	0.50	1737	4054	0.69
22.09.09, 01:00	15.3	-	-	-	-	-	-	0.055	1.8	0.86	1823	4311	0.83
22.09.09, 02:00	13.1	-	-	-	-	-	-	0.039	1.6	0.44	1643	4150	0.62
22.09.09, 03:00	12.8	-	-	-	-	-	-	0.063	1.7	0.78	1729	4238	0.64
22.09.09, 04:00	13.0	-	-	-	-	-	-	0.046	1.6	0.81	1571	4142	0.60
22.09.09, 05:00	13.9	-	-	-	-	-	-	0.054	1.6	0.87	1744	4021	0.66
22.09.09, 06:00	13.9	-	-	-	-	-	-	0.052	1.6	0.73	1515	4036	0.58
22.09.09, 07:00	14.4	-	-	-	-	-	-	0.079	1.9	0.85	1884	4483	0.68
22.09.09, 08:00	13.6	-	-	-	-	-	-	0.11	1.7	1.0	1769	4526	0.62
22.09.09, 09:00	16.3	-	-	-	-	-	-	0.10	2.1	1.2	2030	5104	0.86
22.09.09, 10:00	16.9	-	-	-	-	-	-	0.11	2.1	1.6	1901	5031	0.74
22.09.09, 11:00	21.6	-	-	-	-	-	-	0.14	2.8	1.8	2212	6172	0.76
22.09.09, 12:00	25.6	-	-	-	-	-	-	0.14	3.6	2.0	2224	5177	0.78
22.09.09, 13:00	28.9	-	-	-	-	-	-	0.13	4.3	2.1	2316	5166	0.74
22.09.09, 14:00	32.5	-	-	-	-	-	-	0.14	4.8	3.3	2447	5375	0.81

Versuchsablauf:

- 16:00 – 05:00 Uhr Conditioning of your Transformer
- 06:00 – 09:00 Uhr Heating up your Transformer up to 70°C
- 09:00 – 14:00 Uhr Temperatur 70°C hold during Test

Energy Support GmbH · Sperberweg 47 · D - 41468 Neuss T +49 2131 4039607 · F +49 2131 4039608 · info@energy-support.de



**TRANSFORMER-LIFE-MANAGEMENT  
CONFERENCE**

## A general Overview of Analytical Measurement on Transformer Oil

**ENERGY** SUPPORT

Experts in providing mobile Solutions

### Solution of Onlinemeasurement on Transformers according IEC and ASTM Norm

Monitoring of 11 Faultgase – same analysis as Laboratories  
Direct measurement of Total Gas Content  
Forwarding of results via Internet-GSM  
Control measurement possible with internal calibration gas  
Direct evaluation of results with internal expertsystem  
according IEC/ASTM – Duval  
Servicemodul for remote maintenace

Energy Support GmbH . Sperberweg 47 . D - 41468 Neuss T +49 2131 4039607 . F +49 2131 4039608 . info@energy-support.de

**ENERGY** SUPPORT

Experts in providing mobile Solutions

Thank you  
for  
your attention !

Energy Support GmbH . Sperberweg 47 . D - 41468 Neuss T +49 2131 4039607 . F +49 2131 4039608 . info@energy-support.de